

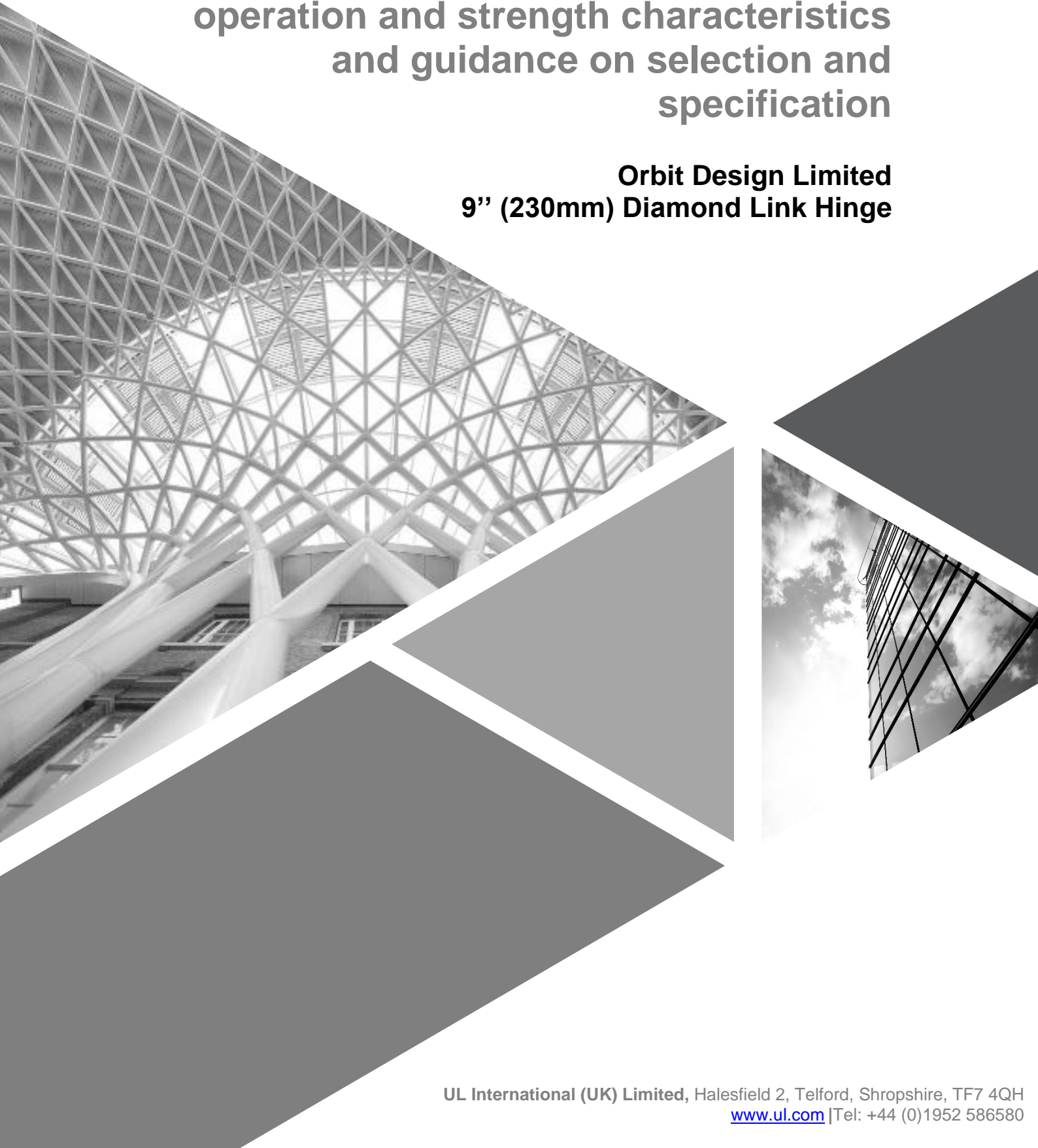

**Technical Report – R4790703268-1  
BS 6375-2:2009 – Performance of  
Windows and Doors, Classification for  
operation and strength characteristics  
and guidance on selection and  
specification**

**Orbit Design Limited  
9” (230mm) Diamond Link Hinge**



**Contents**



1. Introduction .....2  
2. Summary of Results .....3  
3. Description of Test Sample .....4  
4. Test Arrangement .....7  
5. Test Procedures .....8  
6. Test Results .....10  
7. System Drawings .....15



## 1. Introduction

This report describes tests carried in order to determine the durability of the sample with respect to operating forces, mechanical strength and resistance to repeated operation of the test specimen supplied as follows:

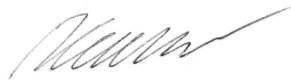
Test Details	
Customer:	Orbit Design Limited The Walnuts Ingleby Road Stanton by Bridge DE73 7HU GB
Product Tested:	9" hinge (230mm) Diamond link hinge fitted to side hung window
Date of Sample Received:	22 <sup>nd</sup> December 2023
Date of Test:	Mechanical Strength: 31 <sup>st</sup> January 2023  Resistance to Repeated Opening & Closing: 3 <sup>rd</sup> – 13 <sup>th</sup> January 2023
Test Conducted at:	UL International (UK) Limited Halesfield 2 Telford Shropshire TF7 4QH
Test Conducted by:	S Ward <i>Senior Laboratory Technician</i> C Holden <i>Senior Laboratory Assistant</i>

Report Authorisation	
Report Compiled by:	R Cadwallader Engineer 
Authorised by:	D Potts Engineering Leader 

UL International (UK) Limited is accredited by the United Kingdom Accreditation Service as UKAS Testing Laboratory No. 5772.

**REPRODUCTION OF THIS DOCUMENT IN WHOLE OR ANY PART THEREOF MUST NOT BE MADE WITHOUT PRIOR WRITTEN PERMISSION FROM UL INTERNATIONAL (UK) LIMITED.**

This report and the results shown within are based upon the information, drawings, samples and tests referred to in the report. The results obtained do not necessarily relate to samples from the production line of the above named company and in no way constitute any form of representation or warranty as to the performance or quality of any products supplied or to be supplied by them. UL or its employees accept no liability for any damages, charges, cost or expenses in respect of or in relation to any damage to any property or other loss whatsoever arising either directly or indirectly from the use of the report.



## 2. Summary of Results

The following summarises the results of testing carried out, in accordance with the relevant testing and classification standards.

The performance of the sample tested has been assessed against the criteria described in below standards.

<b>Test Method &amp; Classification Standard</b>	<b>Description</b>	<b>Classification</b>
BS EN 12046-1: 2003 BS EN 13115:2001	Operating forces	Class 1
BS EN 13115:2001	Mechanical strength	Class 3
BS EN 14608: 2004 BS EN 13115:2001	Racking	600 N
BS EN 14609: 2004 BS EN 13115:2001	Static torsion	300 N
BS EN 1191:2000	Repeated opening and closing	Class 3

More comprehensive details are reported in Section 6.

**Note:** *These results are valid only for the conditions under which the test was conducted.*

**Note:** *All measurement devices, instruments and other relevant equipment were calibrated and traceable to National Standards.*

### 2.1 Decision Rule

Classifications reported in Section 6 indicate that the product conforms with the relevant accuracy requirements of the testing standards (as summarised below) and the expanded measurement uncertainty ( $k=2$  for approximately 95% coverage probability) is no greater in magnitude than the accuracy requirements defined in Section 2 of BS EN 947 - 1999, BS EN 948 - 1999, BS EN 949 - 1999, BS EN 950 - 1999, and Section 5 of BS EN 12046-1 - 2003 and/or BS EN 12046-2 - 2000.

### 2.2 Measurement Uncertainty

The reported expanded uncertainty is based on a standard uncertainty multiplied by a coverage factor  $k = 2$ , providing a level of confidence of approximately 95%, and for the operating forces is +/- 1.6%, for mechanical strengths is +/- 0.10% and for indentation during impacting is +/- 0.29%.



### 3. Description of Test Sample

The description of the test sample in this section has been supplied by the customer and has not been verified by UL International (UK) Limited.

See Section 7 for test sample drawings as supplied by Orbit Design Limited.

<b>Product range name:</b>	Diamond Link Hinges
<b>Project name to appear on front page of the test report:</b>	9" (230mm) Diamond Link Hinge
<b>Configuration:</b>	9" (230mm) Diamond Link Hinge 16.5mm stack height
<b>Opening direction:</b>	Right Opening (As viewed from the inside)
<b>Product manufacturer:</b>	Orbit Designs Ltd
<b>Is the sample typical of normal production?</b>	Yes
<b>Please define the closing condition of the sample: i.e. closed, fastened, latched, locked and secured etc.</b>	Closed and locked
<b>Weight of Sample including subframe (kg):</b>	40kg Approximately
<b>Weight of Sash (kg)- applicable for sample tested with accordance with BS 6375-2:2009</b>	30kg

Outer Frame			
<b>Outer frame width:</b>	600mm	<b>Outer frame material:</b>	UPVC
<b>Outer frame height:</b>	1500mm	<b>Outer frame gasket:</b>	EPDM
<b>Outer frame Part Numbers</b>		<b>Gasket type:</b>	Standard Co-Extruded
Top:	EWS 7721	<b>Manufacturer:</b>	Eruocell
Bottom:	EWS 7721	<b>Product name:</b>	Logik 70 Ovolo Main Frame
Lock side:	EWS 7721	<b>Product code:</b>	EWS7312
Hinge side:	EWS 7721	<b>Threshold</b>	No Threshold
<b>Outer frame section size</b>		<b>Manufacturer:</b>	NA
Width:	70mm	<b>Product name:</b>	NA
Depth:	60mm	<b>Product code:</b>	NA
<b>Reinforcing:</b>		<b>Material:</b>	NA
<b>Manufacturer:</b>	Eorocell	<b>Outer frame joint method</b>	
<b>Product name:</b>	Frame Reinforcement	<b>Head:</b>	Welded
<b>Product code:</b>	EWS 7621S	<b>Foot:</b>	Welded
<b>Material:</b>	Steel	<b>Surface Finish</b>	White/Smooth



<b>Leaf</b>			
<b>Leaf/Casement width:</b>	500mm	<b>Leaf/ Casement material:</b>	UPVC
<b>Leaf/ Casement height:</b>	1400mm	<b>Leaf/ Casement gasket</b>	EPDM
<b>Leaf/ Casement Part Numbers</b>		Gasket type:	Standard Co-Extruded
Top:	EWS 7705	Manufacturer:	Eurocell
Bottom:	EWS 7705	Product name:	Logic 70 Ovolo T Sash
Lock side:	EWS 7705	Product code:	EWS 7705
Hinge side:	NA	<b>Leaf midrail:</b>	No Midrail
<b>Leaf/ Casement section size</b>		Manufacturer:	NA
Width:	75mm	Product name:	NA
Depth:	70mm	Product code:	NA
<b>Reinforcing:</b>	NA	Material:	
Manufacturer:	Eurocell	<b>Leaf/Casement joint method</b>	
Product name:	Sash Reinforcement	Head:	Welded
Product code:	EWS 7604S	Foot:	Welded
Material:	Steel	<b>Surface Finish</b>	Smooth White
<b>Glazing</b>			
<b>Glass unit</b>	MDF Weighted Panel	<b>Glazing gasket</b>	
Manufacturer:	NA	Gasket type:	Co Extruded
Inner thickness:	NA	Manufacturer:	Eurocell
Spacer material:	NA	Product name:	Logic 70 Ovolo Bead
Outer thickness:	24mm	Product code:	EWS7312
Unit sizes:	1320mm x 920mm	<b>Glazing clip</b>	No Glazing Clip
<b>Bead</b>		Manufacturer:	NA
Manufacturer:	Eurocell	Product name:	NA
Product name:	Logik 70 Ovolo Bead	Product code:	NA
Product code:	EWS7312	<b>Glazing tape details</b>	No Glazing Tape
Bead size:	Standard	Manufacturer:	NA
Bead material:	UPVC	Product name:	NA
		Product code:	NA



Hardware				
	Manufacturer:	Product description:	Product code:	Quantity:
Hinges:	Orbit Designs Ltd	9" (230mm) Diamond Link hinge 16.5mm Stack	01-1-09-16.5	1 pair
Hinge fixing:	Rapierstar	PH2-Cheese head-Gimlet point-4.8 x 25mm	SFG 4.8 x 25 S	16
Hinge protectors:	NA			
Hinge protector fixings:	NA			
Locking hardware:	ERA	Espagnolette	NA	1
Locking hardware fixing:	NA			
Cylinder:	NA			
Cylinder fixing:	NA			
Handle:	NA			
Handle fixings:	NA			
Touch Bar	NA			
Cylinder Support	NA			
Cylinder Escutcheon	NA			
Keeps:	ERA	Espagnolette keep	NA	3
Keep fixings:	NA			
Drip bar:	NA			
Drip bar fixings:	NA			
Additional Hardware:	NA			

#### Confirmation

Customer is to confirm that the samples provided for testing are representative of standard production. Please note: the details given above, as well as the drawings supplied by the customer as confirmed as typical of normal production are not verified by UL International (UK) Limited.

Company:	ORBIT DESIGNS LTD
Name:	Terry Dolman
Position:	Design Manager
Date:	16-02-2023



## **4. Test Arrangement**

### **4.1 Test Rig**

The test sample was mounted in to a 100 x 75 mm timber sub-frame in accordance with manufacturer's installation requirements and was secured into the test rig ready for testing.

### **4.2 Instrumentation**

#### **4.2.1 Force Measurement**

Calibrated force gauges and load cells were used to measure operation forces to +/- 5%.

#### **4.2.2 Time**

A calibrated stopwatch was used to measure/record time

#### **4.2.3 Torque**

A calibrated torque meter was used for recording forces required to operate any finger operated hardware with an accuracy of +/- 5%

#### **4.2.4 Scales**

The mass of the opening leaf was measured using scales accurate to +/- 2%

#### **4.2.5 Measuring Tape**

A measuring tape and rule accurate to +/- 0.5mm were used

#### **4.2.6 Impactor**

An impactor consisting of two pneumatic tyres as specified in BS EN 12600:2002 together with two steel weights of equal mass and a total mass of 50 kg  $\pm$  0.1 kg was used for impacting

#### **4.2.7 Temperature & Humidity**

A digital data logger capable of measuring temperature with an accuracy of  $\pm$  1°C and humidity with an accuracy of  $\pm$  5 %Rh was used.





## 5. Test Procedures

### 5.1 Sequence of Testing

#### Sample 1

1. Operating Forces
2. Resistance to Racking
3. Operating Forces
4. Resistance to Static Torsion
5. Operating Forces

#### Sample 2

6. Operating Forces
7. Resistance to Repeated Opening and Closing
8. Operating Forces

### 5.2 Resistance to racking

Prior to the test, the window was opened and closed 5 times to an angle of either 90° or its maximum extent in relation to the plane of the frame.

The window vent was opened to an angle of either 90° or its maximum extent in relation to the plane of the frame and a pre-load was then applied to the opening edge corner of the window and held for a period of 60 secs, the load was removed and following a rest period of 60 secs a measurement was recorded at the opposite opening edge corner to that which the load was applied.

The test load was then applied to the same position as that described above and held for a period of 5 mins. On completion of the 5 mins a measurement was recorded at the opposite opening edge corner to that which the load was applied, the load was then removed.

Following a 1-minute period with no load applied to the sample, a further measurement was recorded in order to determine any residual deformation.

### 5.3 Resistance to static torsion

Prior to the test, the window was opened and closed 5 times to an angle of either 90° or its maximum extent in relation to the plane of the frame as required by the test standard

The window vent was opened to an angle of either 90° or its maximum extent in relation to the plane of the frame and the opposite opening edge corner to that which the load was being applied was locked firmly in position. A pre-load was then applied to the opening edge corner of the window, and held for a period of 60 secs, the load was removed and following a rest period of 60 secs a measurement was recorded at the loading position.

With the opposite opening edge corner to that which the load was being applied locked firmly in position, the test load was then applied to the same loading point and held for a period of 5 mins. On completion of the 5 mins a measurement was recorded at the loading position and the load was then removed.

Following a 1-minute period in which no load was applied to the sample, measurement at the loading position was recorded.



## 5.4 Operating forces

Prior to the test, all moving parts of the window were operated 5 times as required by the test standard.

The minimum forces, to disengage the hardware, then open and close to/from a distance of 100mm before finally engaging and securing the hardware, was recorded.

The sequence was repeated three times with the results averaged to obtain the final value with a 1-minute rest period between each sequence.

## 5.5 Resistance to Repeated Opening and Closing

### 5.5.1 Prior to the test

The mass of the casement, sash or leaf was measured prior to any testing.

With the test sample installed in accordance with clause 6 of EN 1191:2000, the sample was subject to 5 manual operations before the following initial measurements were taken:

- a) The dead load applied by the operating equipment on the casement, sash or leaf
- b) The stroke of the casement, sash or leaf in degrees or millimetres
- c) Dimensions at datum points were taken in order to establish a nominal set of dimensions
- d) The operating forces, measured in accordance with BS EN 12046-1:2003

The cylinders were adjusted in accordance with the operation of the hardware its reference velocity and attainment of forces within the specified limits, the rest times and strokes.

### 5.5.2 Cyclic test

The test was configured for the correct number of cycles according to the required classification as outlined in BS EN 12400:2002.

At every period equal to 25% of the specified total test cycles (or less if specified by the manufacturer for lubrication) the test was stopped, and the test specimen examined. The test was continued and paused at the examination periods throughout its duration as defined above.

### 5.5.3 Following the test

Following the completion of the defined number of cycles, the following measurements were taken:

- a) The dead load applied by the operating equipment on the casement, sash or leaf
- b) The stroke of the casement, sash or leaf in degrees or millimetres
- c) Dimensions at datum points were taken in order to establish a nominal set of dimensions
- d) The operating forces, measured in accordance with BS EN 12046-1:2003



## 6. Test Results

### 6.1 Lab Conditions

The conditions measured inside the laboratory were as follows:

	Temperature (°C)	Humidity (%RH)
At start of test	21.8	48.6
At completion of test	20.4	36.0

### 6.2 Operating forces

The results of the tests carried out are as follows:

Description	Sash	Classification
Disengage Hardware (N)	13.1	2
Commence Opening (N)	18.3	2
Commence Closing (N)	30.1	1
Engage Hardware (N)	18.9	2
Overall Classification according to BS EN 13115:2001		1

The overall classification for operating forces is: **CLASS 1**

### 6.3 Resistance to Racking

	Sash
Test Load (N)	600
Deformation Under Load (mm)	4.18
Residual Deformation Following Test (mm)	0.76

Following the test there were no signs of damage to the sample or loss of functionality.



#### 6.4 Operating forces

The results of the tests carried out are as follows:

Description	Sash	Classification
Disengage Hardware (N)	13.5	2
Commence Opening (N)	23.4	2
Commence Closing (N)	18.7	2
Engage Hardware (N)	19.7	2
Overall Classification according to BS EN 13115:2001		2

#### 6.5 Resistance to static torsion

	Primary Leaf
Test Load (N)	300
Deformation Under Load (mm)	18.40
Residual Deformation Following Test (mm)	0.98

Following the test there were no signs of damage to the sample or loss of functionality.

#### 6.6 Operating forces

The results of the tests carried out are as follows:

Description	Sash	Classification
Disengage Hardware (N)	16.5	2
Commence Opening (N)	19.1	2
Commence Closing (N)	24.4	2
Engage Hardware (N)	23.7	2
Overall Classification according to BS EN 13115:2001		

#### 6.7 Overall Classification for Mechanical Strength

The overall classification for mechanical strength is: **CLASS 3**



## 6.8 Resistance to Repeated Opening and Closing

### 6.8.1 Initial Measurements

Description	Primary Leaf
Mass of sash (kg)	27.9
Dead load applied by the operating equipment (kg)	0.0
Stroke of casement (°)	90

The operating forces measured before the test are as follows:

Description	Primary Leaf	Classification
Disengage Hardware (N)	16.4	2
Commence Opening (N)	16.5	2
Closing force (N)	32.5	1
Engage Hardware (N)	20.9	2
Overall Classification according to BS EN 13115:2001		1

### 6.8.2 Cycle Test

The number of cycles completed by the sample was **20,000** as required by **Class 3** of the standard.

The sample was lubricated as specified by the manufacturer at each period equal to 2500 cycles or 25% whichever the greater and adjustments were carried out as follows:

Hardware was checked and lubricated.

Throughout and immediately following the test, the sample was checked and there were no signs of damage or loss of functionality.

Following the completion of 20,000 cycles the sample was lubricated as specified by the manufacturer and completed an additional 5,000 cycles at the request of the customer.

Throughout and immediately following the test, the sample was checked and there were no signs of damage or loss of functionality.

### 6.8.3 Datum Measurements

Observations and measurement of the datum points were measurement from a point 50mm from each edge of the casement in relation to the outer frame.

Description	Dimension (mm)							
	1	2	3	4	5	6	7	8
Before cyclic test	35.4	35.4	35.4	35.4	35.4	35.4	35.4	35.4
After cyclic test	35.4	35.4	35.4	35.4	35.4	35.4	35.4	35.4
Difference	0.0	0.0	0.0	0.0	0.0	0.0	0.0	0.0



#### 6.8.4 Final Measurements – 20,000 Cycles

Description	Primary Leaf
Mass of sash (kg)	27.9
Dead load applied by the operating equipment (kg)	0.0
Stroke of casement (°)	90

The operating forces measured following the test are as follows:

Description	Primary Leaf	Classification
Disengage Hardware (N)	11.7	2
Commence Opening (N)	15.6	2
Closing force (N)	21.5	2
Engage Hardware (N)	14.6	2
Overall Classification according to BS EN 13115:2001		2

#### 6.8.5 Variation in Performance

The following calculation is used to assess the variation in performance as a result of the repeated opening and closing test

$$V(\%) = 100 \left( \frac{Pe}{Pi} - 1 \right)$$

**V** is the percentage variation in performance

**Pe** is the operating forces measured after the test

**Pi** is the operating forces measure before the test

Description	Variation in performance %
Disengage Hardware (N)	-28.7
Commence Opening (N)	-5.5
Commence Closing (N)	-33.8
Engage Hardware (N)	-30.1

The overall classification for repeated opening and closing is: **CLASS 3**



### 6.8.6 Final Measurements – 25,000 Cycles

Description	Primary Leaf
Mass of sash (kg)	27.9
Dead load applied by the operating equipment (kg)	0.0
Stroke of casement (°)	90

The operating forces measured following the test are as follows:

Description	Primary Leaf	Classification
Disengage Hardware (N)	8.0	2
Commence Opening (N)	9.2	2
Closing force (N)	19.6	2
Engage Hardware (N)	9.8	2
Overall Classification according to BS EN 13115:2001		2

### 6.8.7 Variation in Performance

The following calculation is used to assess the variation in performance as a result of the repeated opening and closing test

$$V(\%) = 100 \left( \frac{Pe}{Pi} - 1 \right)$$

**V** is the percentage variation in performance

**Pe** is the operating forces measured after the test

**Pi** is the operating forces measure before the test

Description	Variation in performance %
Disengage Hardware (N)	-51.2
Commence Opening (N)	-44.2
Commence Closing (N)	-39.7
Engage Hardware (N)	-53.1



### 7. System Drawings

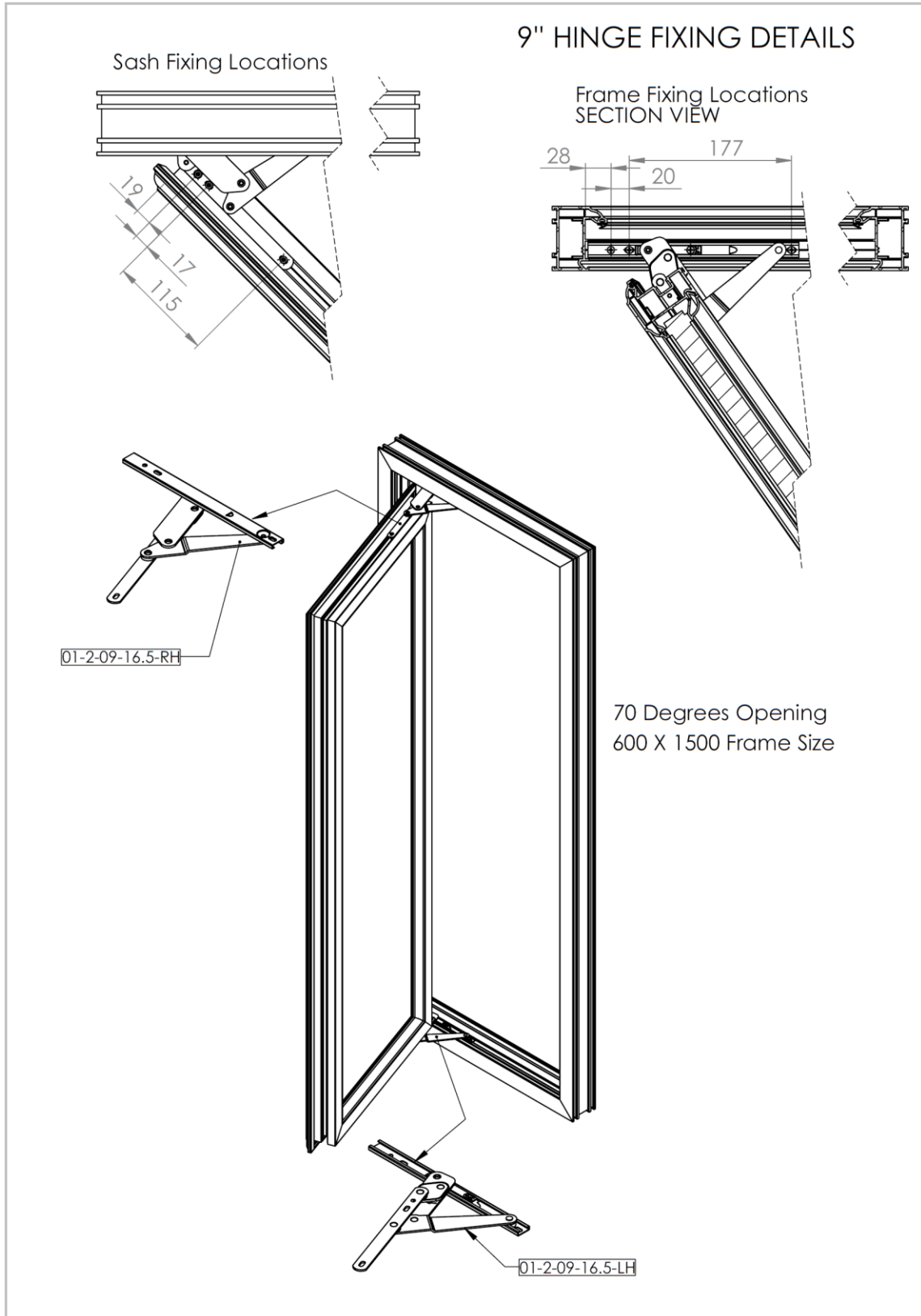



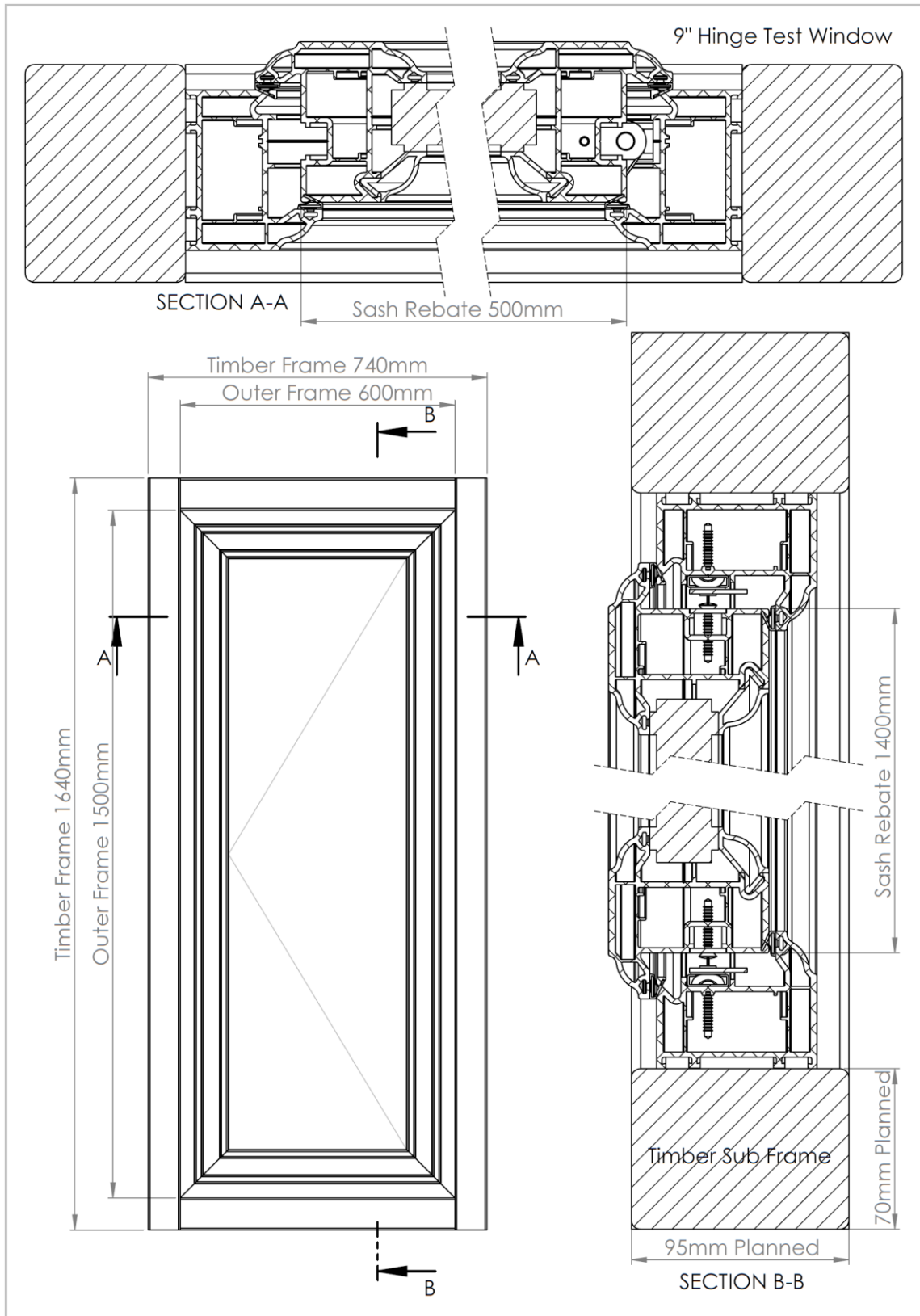

----- END OF REPORT -----





Facade Testing



Onsite Testing





Product Certification



Window & Door Testing

**UL International (UK) Limited is an independent UKAS accredited testing laboratory and certification body. We provide a comprehensive range of services to the building and construction industries, either onsite or at our own state-of-the-art test laboratory in Telford, Shropshire, in the heart of industrial England.**

 +44 (0) 1952 586580  
 [www.ul.com](http://www.ul.com)